

**SINGER**  
**29K51,K53,K55,K56**

Form 18436  
March, 1930  
Printed in U. S. A.

# LIST OF PARTS



From the library of: Diamond Needle Corp

MACHINES  
Nos. 29K51, 29K53, 29K55  
and 29K56

---

\*\* A TRADE-MARK OF

THE SINGER MANUFACTURING COMPANY

## INSTRUCTIONS FOR OILING

---

To ensure easy running and prevent unnecessary wear of the parts which are in movable contact, the machine requires oiling and when in continuous use, "TYPE B" or "TYPE D" OIL, sold only by Singer Sewing Machine Company, should be applied at least twice each day to all oil holes marked "OIL".

COPYRIGHT, U. S. A., 1926  
BY THE SINGER MANUFACTURING CO.  
ALL RIGHTS RESERVED FOR ALL COUNTRIES

## INDEX

---

	PAGE
ACCESSORIES.....	16-17
BOBBIN WINDERS.....	18
MACHINE BASES FOR POWER TABLES.....	17
"    No. 29 K 51.....	7
"    "    29 K 53.....	13
"    "    29 K 55.....	14
"    "    29 K 56.....	16
NUMERICAL LIST OF PARTS.....	21
OBSOLETE PARTS.....	19
SINGERLIGHT.....	18

From the library of: Diamond Needle Corp

## INSTRUCTIONS FOR ORDERING

In ordering from this list, use **ONLY** the part **NUMBER** in the **FIRST** column.

The number stamped on a Sewing Machine part is in every case the number of the single part only.

Every combination of parts sent out as such has its specific number, which, although not stamped on the parts, must be used when ordering the combination.

Each number always indicates the **SAME PART** in whatever list it appears, or for whatever machine.

The letters after some of the numbers indicate the style of finish only, as follows:

- A—Hardened, Polished, Nickel Plated and Buffed
- B—Polished, Nickel Plated and Buffed
- C—Hardened Only
- D—Polished Only
- E—Soft, Not Polished
- F—Hardened and Polished
- H—Blued
- J—Nickel Plated Only
- K—Hardened and Nickel Plated
- L—Brass Plated
- M—Oxidized
- N—Japanned, Dull
- P—Japanned, Bright
- R—Merlized
- T—Copper Plated
- T. A.—Hardened, Polished, Copper and Nickel Plated and Buffed
- T. B.—Copper and Nickel Plated and Polished
- T. J.—Copper and Nickel Plated Only
- T. K.—Hardened, Copper and Nickel Plated
- T. M.—Copper Plated and Oxidized
- T. L.—Copper and Brass Plated
- U—Zinc Plated
- V—Silver Plated
- W—Polished and Nickel Plated
- Z—Chromium Plated
- Z. B.—Polished, Nickel Plated, Buffed and Chromium Plated
- Z. J.—Nickel and Chromium Plated

These letters **MUST BE USED** when they appear in the list; and **AFTER** the number **as** in the list.

In this series:

- 1 to 1500 and 50001 to 51500 are Screw Numbers
- 1501 to 1800 and 51501 to 51800 are Nut Numbers
- 1801 to 2000 and 51801 to 52000 are Roller Numbers
- 2001 to 50000 and 52001 and upward are numbers of Machine Parts

The figures in the second column refer only to the plates, illustrating the parts, and are **NOT TO BE USED** in ordering.

Parts marked with an asterisk (\*) are furnished only when repairs are made at factory.

## LIST OF PARTS COMPLETE FOR

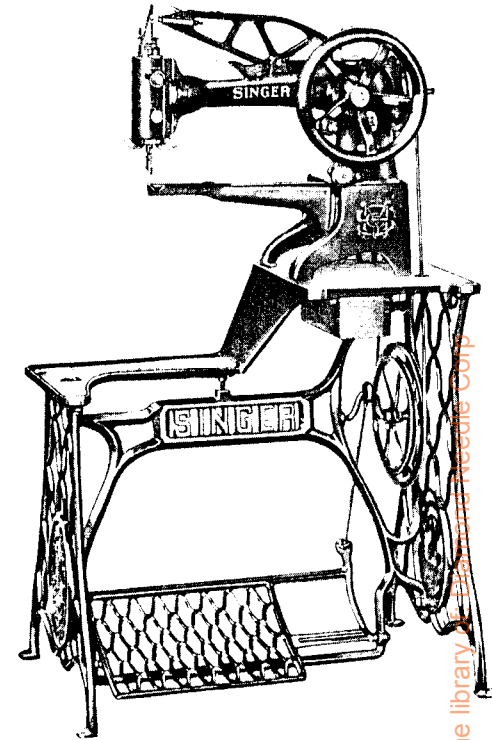

### MACHINE No. 29K51

ON STAND No. 25278

(List Price of the Machine does not include stand).

12 $\frac{1}{4}$  INCHES FROM NEEDLE TO BASE OF ARM. UNIVERSAL UPPER FEED. OSCILLATING HORIZONTAL SHUTTLE, THE ASSEMBLY OF WHICH IS DETACHABLE AND INTERCHANGEABLE. HELICAL PRESSER FOOT SPRING. CONVENIENT AND POSITIVE ADJUSTMENT OF PRESSER FOOT LIFT. ECCENTRIC ADJUSTMENT FOR SHUTTLE TIMING. SIDE WHEEL. FOR BOOT AND SHOE REPAIRING, SLIPPER WORK, ETC. WIDTH OF LOWER ARM AT ITS END 1 $\frac{1}{8}$  INCHES, DEPTH  $\frac{7}{8}$  INCH.

NO.	PLATE	NAME
*82051	—	Arm with 4449.....

From the library of the University of Toronto



NO.	PLATE	NAME
82013	266	Needle Plate (fine and medium needle holes).....
82014	266	Needle Plate (medium needle holes)....
82015	266	" " (fine and medium needle holes).....
82016	948	Needle Plate (medium and coarse needle holes).....
NOTE: No. 82016 is sent with this Machine unless another Needle Plate is specified on order.		
84D	1485	Needle Plate Bearing Screw.....
82061	1483	" " Catch.....
82063	1483	" " " Pin.....
82141	1810	" " " Spring.....
8670	1475	Oil Cup with 8597 and 8695.....
8695	1483	" " Oil Pad (cloth).....
327D	1485	" " Screw.....
8597	1483	" " Spring.....
82144	1810	Pinion Cover Plate.....
393E	1485	" " " Screw.....
82133	1810	Rack.....
82143	1810	" and Pinion Box.....
82147	—	Rack and Pinion Box complete, Nos. SS 468E, 82068 to 82070, 82133, 82143, 82144, two each 393E, 82071 and 82072
82066	1483	Rack and Pinion Box Position Pin.....
1177E	1485	" " " " Screw.....
82010	1473	Shaft.....
4449	1474	" Bushing.....
8604	1482	Shuttle Bobbin.....
*8654	1482	" Body.....
662D	1485	" Tension Regulating Screw.....
8611	1482	" " Spring.....
8603	—	Shuttle complete, Nos. 662D, 8604, 8611 and 8654.....
NOTE: No. 8603 is sent with this Machine unless otherwise specified on order.		
81876	1482	Shuttle Tension Spring.....
81964	—	Shuttle complete, Nos. 662D, 8604, 8654 and 81876.....
82068	1482	Shuttle Carrier with 241D and 8610....
82069	1478	" " Driving Pinion.....
82070	1478	" " " " Bushing.....
SS 468E	1485	" " " " Screw..
82071	1478	" " Following Pinion.....
82072	1478	" " " " Stud..

NO.	PLATE	NAME
8610	1482	Shuttle Carrier Spring.....
241D	1485	" " " " Screw.....
82073	1474	Shuttle Driving Cam with SS 235C.....
82122	—	" " " and Gear, Nos. 81872 and 82073.....
81872	1481	Shuttle Driving Cam Gear.....
3012	1483	" " " " Pin.....
SS 235C	1485	" " " " Set Screw..
1808	1486	" " " Roller and Stud..
82142	1809	" " Lever with 1808.....
7D	1485	" " " Bearing Screw..
82075	1482	" " " Connecting End (front).....
82076	1482	Shuttle Driving Lever Connecting End (back).....
8645	1483	Shuttle Driving Lever Connecting End Pin (front).....
14026	1483	Shuttle Driving Lever Connecting End Pin (back).....
82077	1475	Shuttle Driving Lever Connecting Rod
89E	1485	" " " " " " Hinge Screw.....
82078	—	Shuttle Driving Lever Connecting Rod complete, Nos. 8645, 14026 and 82075 to 82077.....
1381K	1485	Shuttle Driving Lever Eccentric Stud
1520R	1486	" " " " " " Nut.....
8601	1483	Spool Pin.....
8615	1483	Stitch Regulator.....
8616	1483	" " " Gib.....
291D	1485	" " Thumb Screw.....
668D	1481	Tension (top) Adjusting Stud.....
1560D	1486	" " " " " Thumb Nut.....
8617	1479	Tension (top) Cup (release).....
8618	1481	" " Disc.....
84113	1481	" " " Washer (leather)....
8619	1481	" " Spring.....
413D	1485	" (side) Adjusting Stud.....
1560D	1486	" " " " " Thumb Nut.....
2102	1481	Tension (side) Disc.....
2103	1481	" " Spring.....
82116	1483	" " Thread Guide Pin.....
8620	1483	Thread Eyelet (head of arm).....
207F	1485	" " Screw.....

From the library of the American Needle Co.

NO.	PLATE	NAME
82079	1479	Vibrating Presser Lifting Lever.....
41D	1485	" " " " Screw
82080	1479	" " " " Shaft
82132	---	" " " " "
		82080 with 82081 and 82117.....
82082	1481	Vibrating Presser Lifting Lever Shaft Adjusting Lever.....
515E	1485	Vibrating Presser Lifting Lever Shaft Adjusting Lever Clamping Screw.....
8568	1483	Vibrating Presser Lifting Lever Shaft Adjusting Lever Clamping Screw Rivet
648J	1485	Vibrating Presser Lifting Lever Shaft Adjusting Lever Hinge Screw.....
82081	1481	Vibrating Presser Lifting Lever Shaft Lever with 454c.....
82117	1483	Vibrating Presser Lifting Lever Shaft Lever Pin.....
454c	1485	Vibrating Presser Lifting Lever Shaft Lever Screw.....
RR 18	1486	Vibrating Presser Roller.....
81868	1483	" " " Pin.....
82083	1475	" " Spring (light).....
82129	1477	" " " (heavy).....
NOTE: No. 82129 is supplied with this machine unless otherwise specified on order.		
82130	1477	Vibrating Presser Spring Bar.....
NN 88D	1486	" " " " Adjusting Nut.....
82131	1478	Vibrating Presser Spring Bar Collar.....
179E	1485	" " " " " Screw

SINGER Needles should be used  
in SINGER Machines  
These Needles and their Containers  
are marked with the  
Company's Trade Mark "SIMANCO.\*\*" 1

Needles in Containers marked  
"FOR SINGER MACHINES"  
are NOT SINGER made needles. 2

## PARTS SPECIAL TO MACHINE No. 29K53

**FOR BOOT AND SHOE REPAIRING, SLIPPER WORK, ETC.  
WIDTH OF LOWER ARM AT ITS END 1 INCH, DEPTH 7/8  
INCH.**

This machine is the same as 29K51 with the  
following exceptions:

NO.	PLATE	NAME
*82094	---	Bed.....
*82095	---	Lower Arm (narrow).....
*82096	---	Lower Arm and Bed complete, Nos. 82091, 82095 and four 123E.....
123E	1485	Lower Arm and Bed Binding Screw.....
82030	1475	Needle Bar.....
82031	---	Needle Bar complete, Nos. SS 50E, 8656, 81858, 82030 and two SS 1330.....
82032	948	Needle Plate (fine and medium needle holes).....
82033	948	Needle Plate (medium and coarse needle holes).....

NOTE: No. 82033 is sent with this machine unless  
another Needle Plate is specified on order.

SINGER Needles should be used  
in SINGER Machines  
These Needles and their Containers  
are marked with the  
Company's Trade Mark "SIMANCO.\*\*" 1

Needles in Containers marked  
"FOR SINGER MACHINES"  
are NOT SINGER made needles. 2

From the Library of Diamond Needle Corp

**PARTS SPECIAL TO**

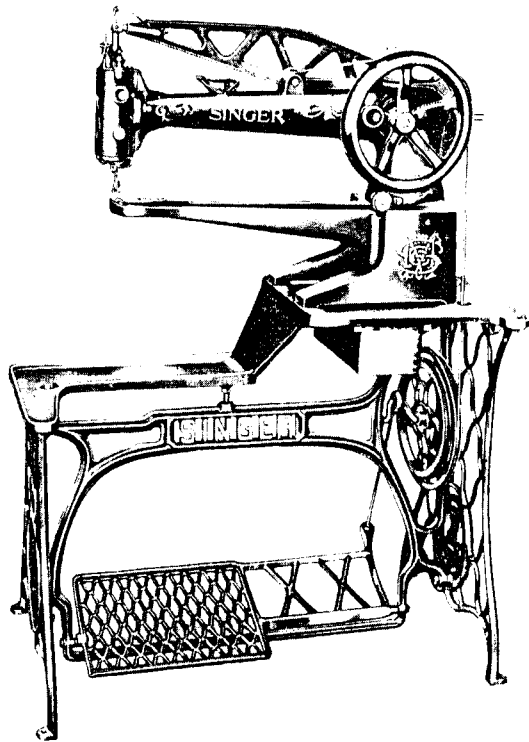

**MACHINE No. 29k55**

**ON STAND No. 94609**

(List Price of the Machine does not include stand).

17½ INCHES FROM NEEDLE TO BASE OF ARM.

**UNIVERSAL UPPER FEED. OSCILLATING HORIZONTAL SHUTTLE THE ASSEMBLY OF WHICH IS DETACHABLE AND INTERCHANGEABLE. HELICAL PRESSER FOOT SPRING. CONVENIENT AND POSITIVE ADJUSTMENT OF PRESSER FOOT LIFT. ECCENTRIC ADJUSTMENT FOR SHUTTLE TIMING. SIDE WHEEL. FOR BOOT AND SHOE REPAIRING, SLIPPER WORK, ETC. LARGE SHUTTLE. FOR WAXED THREAD. WIDTH OF LOWER ARM AT ITS END 1½ INCHES, DEPTH 1¾ INCHES.**

This machine is the same as 29k51 with the following exceptions:

NO.	PLATE	NAME
*82099	—	Arm with 4449.....
8666	1482	Feeding Foot.....

NOTE: No. 8666 is sent with this Machine unless another Feeding Foot is specified on order.

*82100	—	Lower Arm and Bed.....
81939	1475	Needle Bar.....
81940	—	Needle Bar complete, Nos. SS 50e, 8656, 81858, 81939 and two SS 133d.....
81941	1476	Needle Bar Cam and Pulley Wheel with 361c.....
81942	1473	Needle Bar Driving Lever with 1801 and 14026.....
81943	1481	Needle Bar Driving Lever Joint Pin.....
82019	268	Needle Plate (fine and medium needle holes).....
82020	268	Needle Plate (medium and coarse needle holes).....

NOTE: No. 82020 is sent with this machine unless another Needle Plate is specified on order.

82101	1483	Needle Plate Catch.....
82146	1810	Pinion Cover Plate.....
82134	1810	Rack.....
82145	1810	" and Pinion Box.....
82148	—	Rack and Pinion Box complete, Nos. SS 468e, 82105 to 82107, 82134, 82145, 82146, two each 393e, 82108 and 82109.....
82011	1473	Shaft.....
82252	1482	Shuttle Bobbin.....
7868	1482	" " Retaining Spring.....
SS 133d	1485	" " " " Screw.....
*81993	1482	" Body.....
82105	1482	" Carrier.....
82106	1478	" " Driving Pinion.....
82107	1478	" " " " Bushing.....
82108	1478	" " Following Pinion.....
82109	1478	" " " " Stud.....
82110	1473	" Driving Lever Connecting Rod.....
82111	—	Shuttle Driving Lever Connecting Rod complete, Nos. 8645, 14026, 82075, 82076 and 82110.....
SS 132d	1485	Shuttle Tension Regulating Screw.....
81994	1482	" " Spring.....

From the Library of: Diamond Needle Co.



NO.	PLATE	NAME
81951	1482	Shuttle Thread Pull-off.....
404b	1485	“ “ “ Screw.....
81952	-----	Shuttle complete, Nos. SS 132b, SS 133b, 404b, 7868, 81951, 81993, 81994 and 82552.....
80548	1481	Tension (side) Spring (for darning ten- sion or waxed thread).....

## PARTS SPECIAL TO MACHINE No. 29K56

FOR BOOT AND SHOE REPAIRING, SLIPPER WORK, ETC. FOR  
WAXED THREAD. WIDTH OF LOWER ARM AT ITS END  
1  $\frac{3}{8}$  INCHES, DEPTH  $\frac{7}{8}$  INCH. FOR STITCHING IN SMALL  
PLACES.

This machine is the same as 29K51 with the  
following exceptions:

NO.	PLATE	NAME
*82099	-----	Arm with 4119.....
*82112	-----	Lower Arm and Bed.....
81941	1476	Needle Bar Cam and Pulley Wheel with 361c.....
81942	1473	Needle Bar Driving Lever with 1801 and 14026.....
81943	1481	Needle Bar Driving Lever Joint Pin....
82011	1473	Shaft.....
82128	1473	Shuttle Driving Lever Connecting Rod.
82127	-----	Shuttle Driving Lever Connecting Rod complete, Nos. 8645, 14026, 82075, 82076 and 82128.....

## ACCESSORIES

### ACCESSORIES SUPPLIED WITH 29K51 AND 29K53 MACHINES

NO.	PLATE	NAME
-----	-----	Instruction Book.....
128e	1485	Machine Screw (for fastening machine to stand).....
SS 130e	1485	Machine Screw (for fastening machine to power table).....
87345	1810	Machine Screw Washer for SS 130.....
90530	1810	“ “ “ “ 128.....
29x4	-----	Needle (two each, size 19, 21 and 22)...
8590	1475	Needle Bar Threading Wire.....

NO.	PLATE	NAME
36569	-----	Oiler with 36571.....
36571	-----	“ Spout, 1 $\frac{3}{4}$ in. long.....
25537	-----	Screw Driver (machine).....
120378	-----	“ “ (shuttle tension).....
8604	1482	Shuttle Bobbin.....

## ACCESSORIES

### ACCESSORIES SUPPLIED WITH 29K55 MACHINE.

These are the same as for 29K51 Machine with  
the following exceptions:

NO.	PLATE	NAME
137E	1485	Machine Screw (for fastening machine to stand).....
SS 418E	1485	Machine Screw (for fastening machine to power table).....
82833	1810	Machine Screw Washer for SS 418.....
82552	1482	Shuttle Bobbin.....

## ACCESSORIES

### ACCESSORIES SUPPLIED WITH 29K56 MACHINE.

These are the same as for 29K51 Machine with  
the following exceptions:

NO.	PLATE	NAME
137E	1485	Machine Screw (for fastening machine to stand).....
SS 418E	1485	Machine Screw (for fastening machine to power table).....
82833	1810	Machine Screw Washer for SS 418.....

## MACHINE BASES FOR POWER TABLES

NO.	PLATE	NAME
82125	1476	Machine Base, for 29K51 and 29K53 Machines.....
82113	-----	Machine Base, for 29K55 and 29K56 Machines.....
141E	1485	Machine Base Screw (for fastening base to machine for 82125).....
137E	1485	Machine Base Screw (for fastening base to machine for 82113).....
-----	-----	Machine Base Wood Screw 1 in. No. 12 for fastening base to power table....

These bases are only supplied when specified on  
order and are charged extra.

From the Library of: Diamond Needle Corp.

## BOBBIN WINDERS

### BOBBIN WINDER FOR 29K51, 29K53 AND 29K56 MACHINES

NO.	PLATE	NAME
8684	1484	Eccentric.....
SS 469D	1485	“ Thumb Screw.....
82086	1484	Frame.....
128D	1485	“ Screw.....
8651	1484	Spindle.....
81965	—	“ 8651 with 8371.....
8371	1484	“ Pulley.....
2460	1484	“ “ Rubber Ring.....
S2087	1484	Bobbin Winder complete, Nos. 128D, SS 469D, 2460, 8684, 81965 and 82086

### BOBBIN WINDER

#### FOR 29K55 MACHINE

NO.	PLATE	NAME
8684	1484	Eccentric.....
SS 469D	1485	“ Thumb Screw.....
82086	1484	Frame.....
128D	1485	“ Screw.....
82088	1484	Spindle.....
82089	—	“ 82088 with 8371.....
8371	1484	“ Pulley.....
2460	1484	“ “ Rubber Ring.....
82090	1484	Bobbin Winder complete, Nos. 128D, SS 469D, 2460, 8684, 82086 and 82089

## SINGERLIGHT

SINGERLIGHTS ARE SUPPLIED LESS LAMPS, AND THESE SHOULD BE ORDERED SEPARATELY

NO.	PLATE	NAME
*97340	—	Singerlight Bracket (adjustable).....
97353	—	“ “ 97340 with 191815..
50319R	—	“ “ Screw.....
NN 92R	—	“ “ “ Nut.....
2807	—	“ “ “ “ Washer..
97367	—	“ Supporting Bracket.....
SS 56D	—	“ “ “ “ Screw...
97368	—	Singerlight Supporting Bracket complete, Nos. SS 56D, NN 92R, 2807, 50319R and 97367.....

NO.	PLATE	NAME
190744	—	Singerlight Lamp.....

In ordering it is necessary to state the exact voltage required.

*191789	—	Singerlight Nipple.....
*190743	—	“ “ Bushing.....
*191815	—	“ “ Position Pin.....
*191786	—	“ “ Washer (felt) 5/8 in... ..
*191785	—	“ “ “ “ 1/2 in... ..
*191082	—	“ “ “ “ (steel).....
191962	—	Singerlight Toggle Socket complete, Nos. 50564J, 191375, 191381 and 191963 to 191965.....
*191375	—	Singerlight Toggle Socket Base complete, Nos. 191376 and 191377.....
191377	—	Singerlight Toggle Socket Base Hub.....
*191381	—	“ “ “ “ Insulation.....
*191376	—	Singerlight Toggle Socket Base Shell.....
50564J	—	“ “ “ “ “ Set Screw
191965	—	Singerlight Toggle Socket Internal Fitting complete.....
*191963	—	Singerlight Toggle Socket Shell.....
*191964	—	“ “ “ “ “ Insulation
190745	—	“ “ “ “ “ Shade.....
97369	—	Singerlight (less cable and lamp) Nos. 97353, 97368, 190743, 190745, 191082, 191785, 191789, 191962 and two 191786
97354	—	Singerlight Twin Cable, 9 feet long.....
93083	—	“ “ “ “ Plug, Nos. 93084 and 93085, for lamp socket.....
93084	—	Singerlight Twin Cable Plug Body.....
93085	—	“ “ “ “ Cover.....
97370	—	Singerlight (less lamp) with connection for lamp socket, complete, Nos. 93083, 97354 and 97369.....

## OBSOLETE PARTS

NO.	PLATE	NAME
82062	1483	Needle Plate Catch Spring.....
82064	1478	Pinion Cover Plate for 82119.....
82067	1478	Rack for 82119.....
82065	1478	“ and Pinion Box for 82119.....

NO.	PLATE	NAME
82119	---	Rack and Pinion Box complete, Nos. SS 468E, 82064, 82065, 82067 to 82070, two each 393E, 82071 and 82072, for 29K51, 29K53 and 29K56 Machines.
82139	---	Pinion Cover Plate for 82135.
82137	---	Rack and Pinion Box for 82135.
82135	---	Rack and Pinion Box complete, Nos. SS 468E, 82068 to 82070, 82133, 82137, 82139, two each 393E, 82071 and 82072, for 29K51, 29K53 and 29K56 Machines.
82102	1478	Pinion Cover Plate for 82126.
82104	1478	Rack for 82126.
82103	1478	" and Pinion Box for 82126.
82126	---	Rack and Pinion Box complete, Nos. SS 468E, 82102 to 82107, two each 393E, 82108 and 82109, for 29K55 Machine.
82140	---	Pinion Cover Plate for 82136.
82138	---	Rack and Pinion Box for 82136.
82136	---	Rack and Pinion Box complete, Nos. SS 468E, 82105 to 82107, 82134, 82138, 82140, two each 393E, 82108 and 82109, for 29K55 Machine.
82074	1474	Shuttle Driving Lever with 4808.
82084	1475	Vibrating Presser Spring Bar.
82085	1478	" " " " Collar.

**SINGER** Needles should be used  
in **SINGER** Machines  
These Needles and their Containers  
are marked with the  
Company's Trade Mark "SIMANCO.\*\*" <sub>1</sub>

Needles in Containers marked  
"FOR SINGER MACHINES"  
are NOT **SINGER** made needles. <sub>2</sub>

## NUMERICAL LIST OF PARTS

NO.	PLATE	NAME
7D	1485	Shuttle Driving Lever Bearing Screw.
RR 18b	1486	Vibrating Presser Roller for 81861.
41d	1485	" " Lifting Lever Screw.
SS 45E	1485	Balance Wheel Hub Screw.
SS 50E	1485	Needle Bar Clamp Screw for 81857, 81940 and 82031.
SS 56D	---	Singerlight Supporting Bracket Screw for 97368.
66E	1485	Lifter Hinge Screw.
NN 66D	1486	Check Lever Thread Take-up Adjusting Screw Thumb Nut.
84D	1485	Needle Plate Bearing Screw.
NN 88D	1486	Vibrating Presser Spring Bar Adjusting Nut.
89E	1485	Shuttle Driving Lever Connecting Rod Hinge Screw.
NN 92R	---	Singerlight Bracket Screw Nut for 97368.
118E	1485	Arm Base Screw.
123E	1485	Lower Arm and Bed Binding Screw for 82096.
128D	1485	Bobbin Winder Frame Screw for 82087 and 82090.
128D	1485	Head Binding Screw.
128E	1485	Machine Screw (for fastening machine to stand) for 29K51 and 29K53 Machines.
SS 130E	1485	Machine Screw (for fastening machine to power table) for 29K51 and 29K53 Machines.
SS 132D	1485	Shuttle Tension Regulating Screw for 81952.
SS 133D	1485	Needle Bar Thread Tension Spring Screw for 81857, 81940 and 82031.
SS 133D	1485	Shuttle Bobbin Retaining Spring Screw for 81952.
SS 135D	1485	Balance Wheel Handle Spindle for 82120.
137E	1485	Machine Base Screw (for fastening base to machine) for 29K55 and 29K56 Machines.
137E	1485	Machine Screw (for fastening machine to stand) for 29K55 and 29K56 Machines.

PLATE 266—FULL SIZE

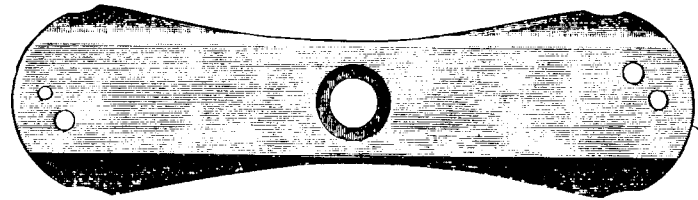

82013

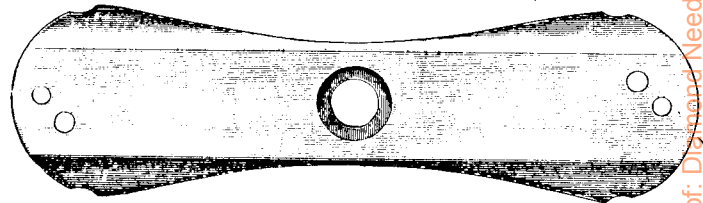
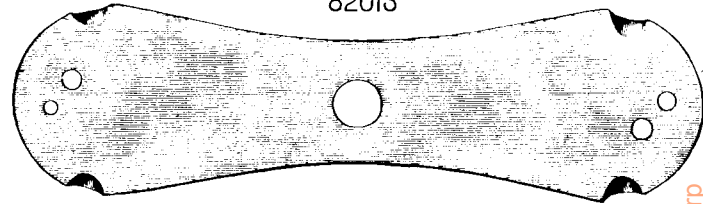

82014

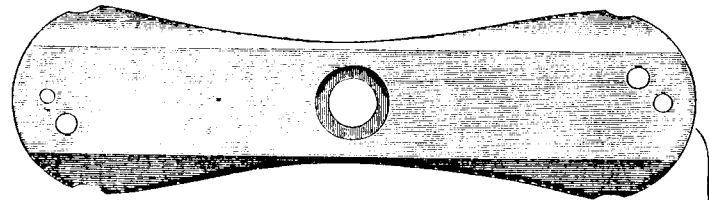
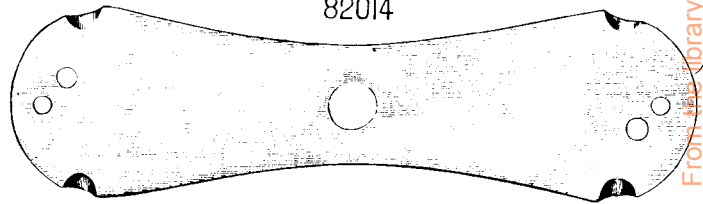

82015

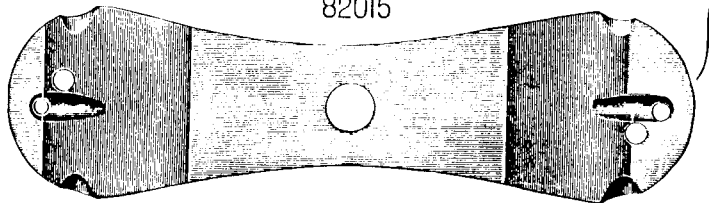

From the library of: Dissonance Needle Corp

PLATE 268—FULL SIZE

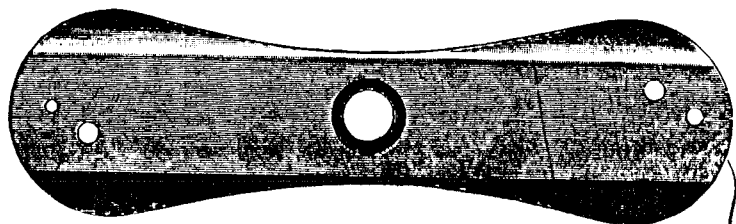

82019

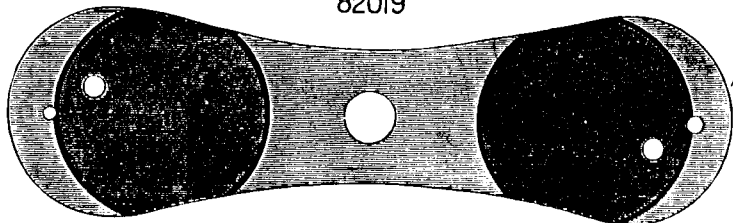

82020

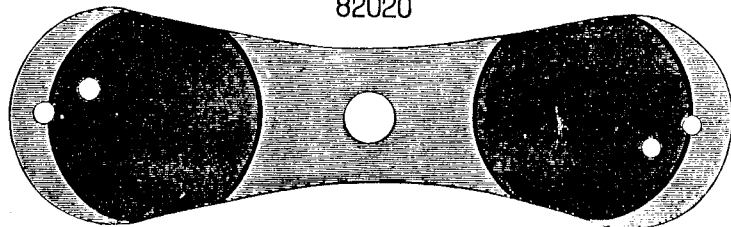
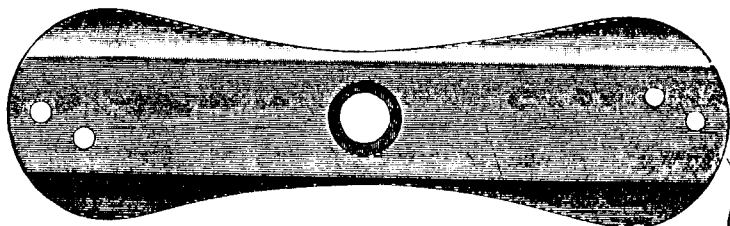
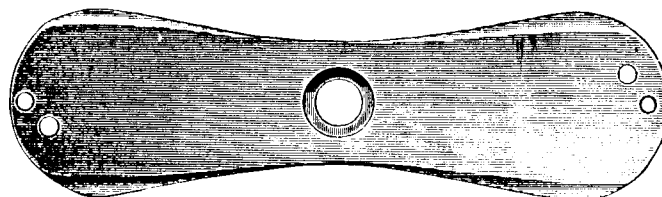
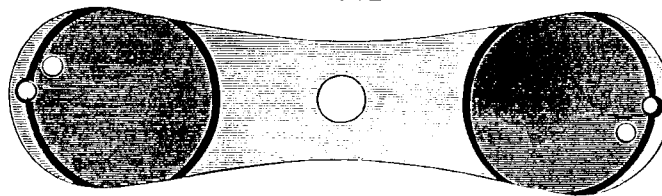

PLATE 948—FULL SIZE



82032



82033

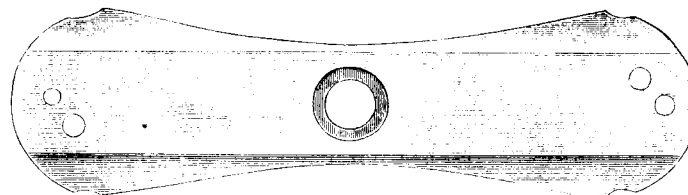
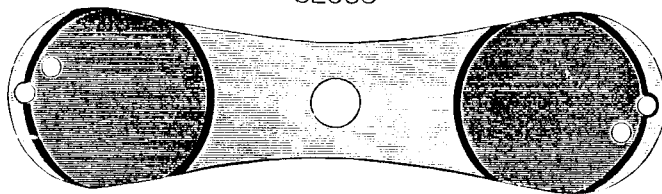
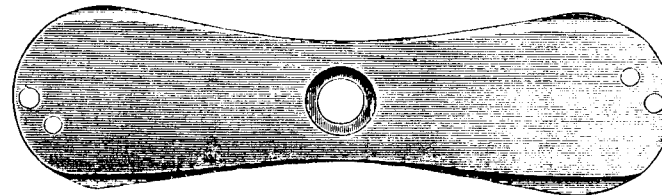

82016

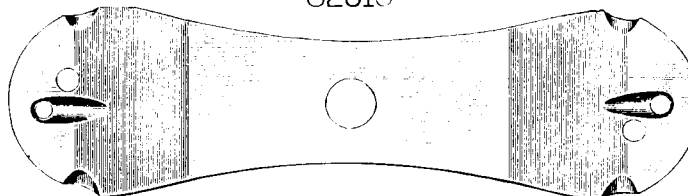

From the library of: Diamond Needle Corp



PLATE 1473—ONE-FOURTH SIZE

PLATE 1474—ONE-HALF SIZE

82011 82010 82110

81865

81942

82128

81859

82074

82053

82058

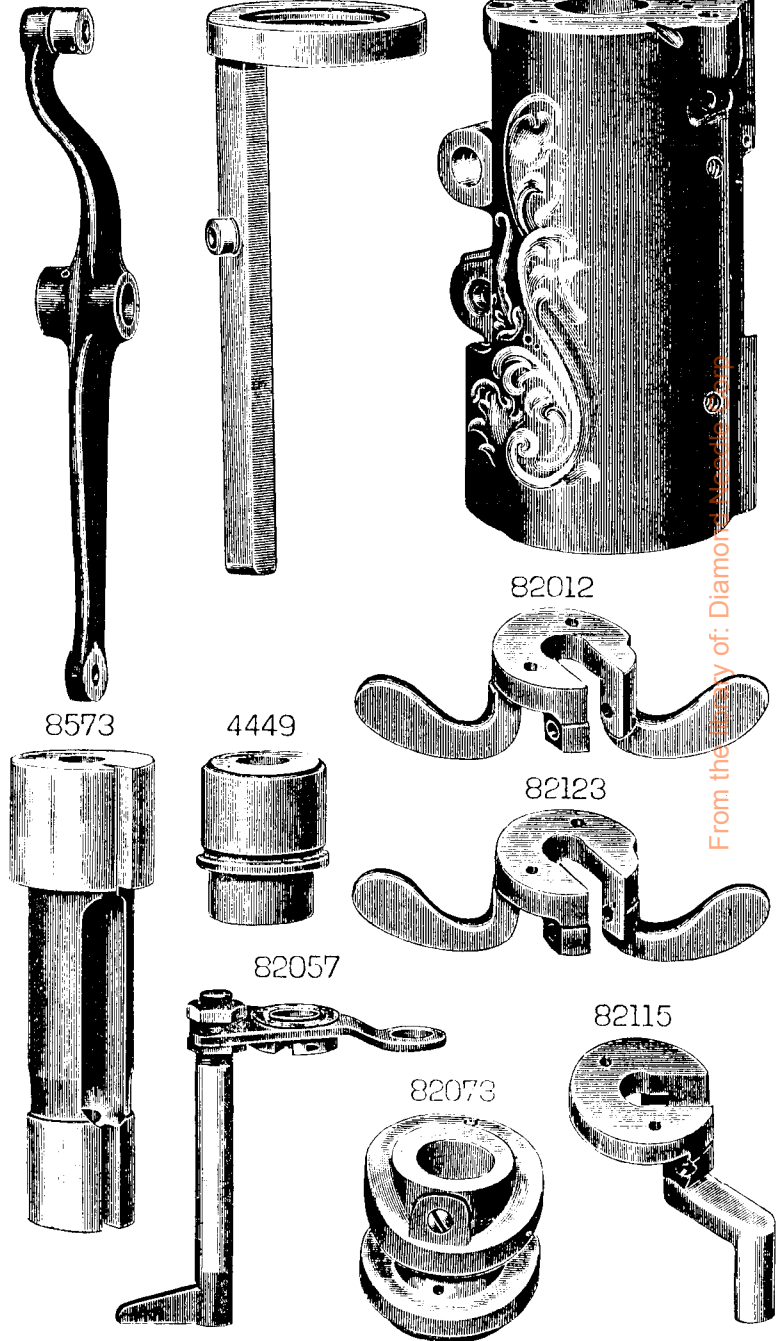

From the Library of: [Diamond.com](http://diamond.com)

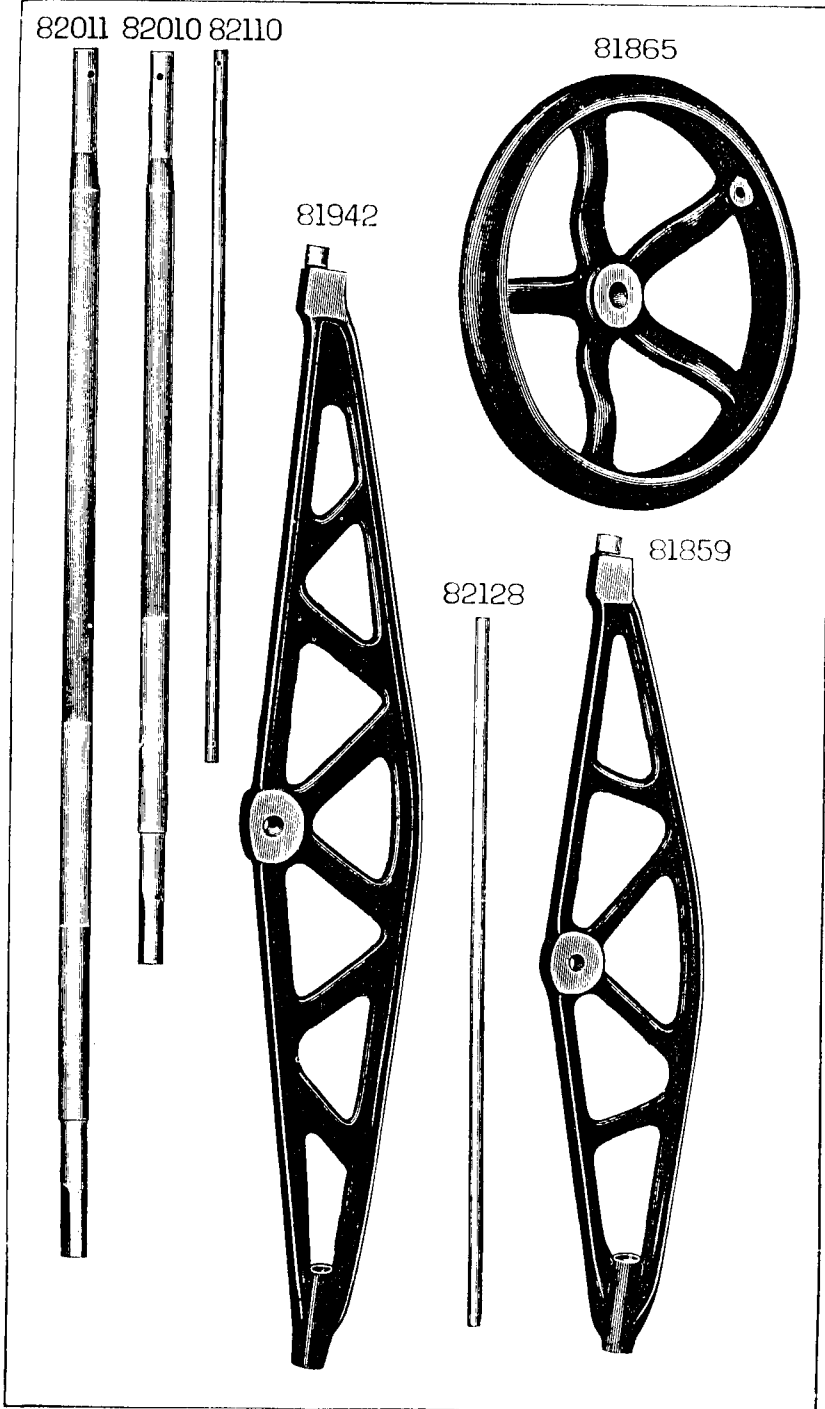
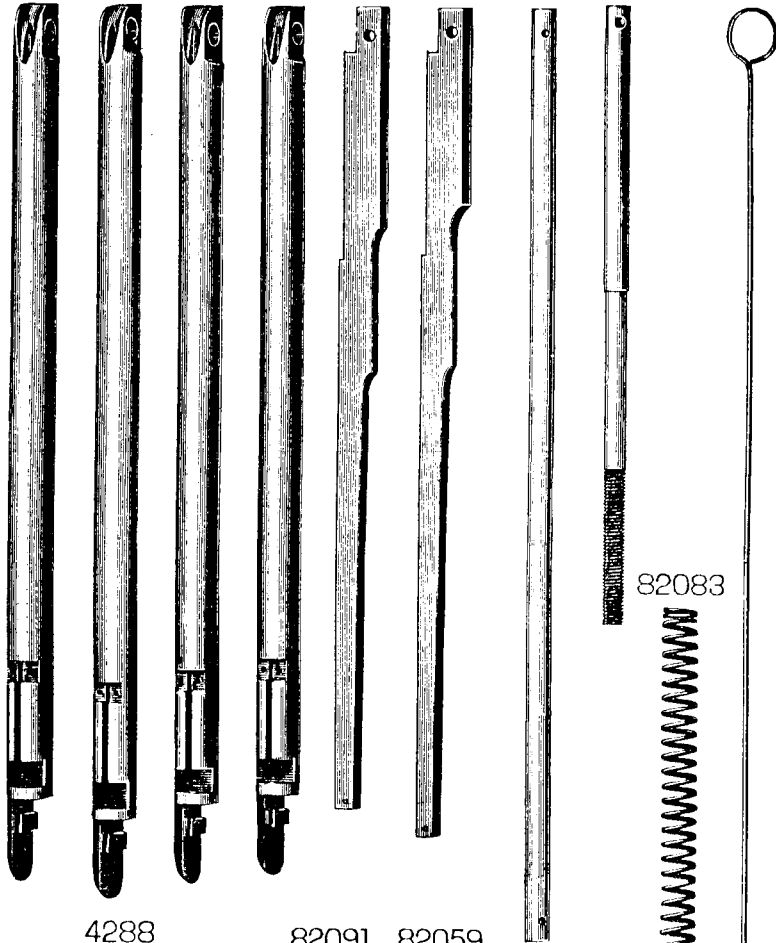

PLATE 1475—ONE-HALF SIZE

8655 81887 81939 82030 8675 81883 82077 82084 8590



4288

82091 82059

8670

82083

PLATE 1476—ONE-FOURTH SIZE

81941

8661

81890

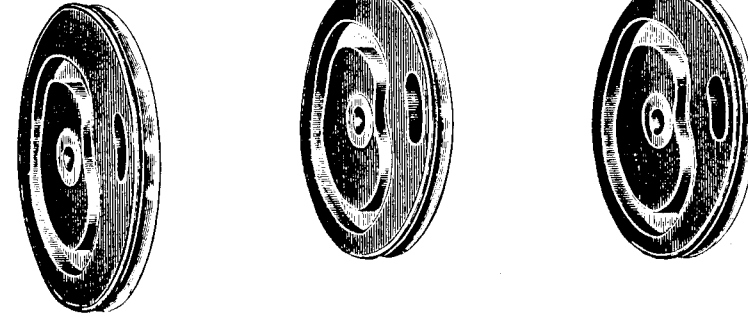

82125

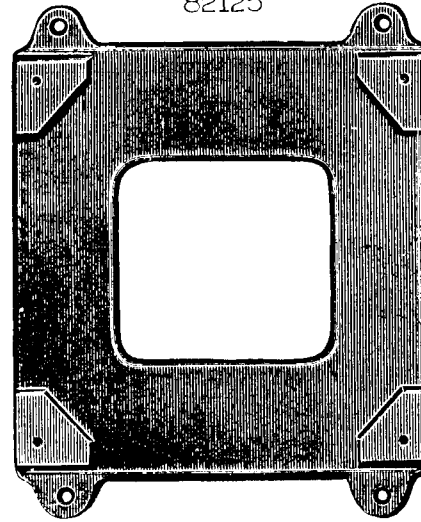

From the library of: Diamond Needle Corp

PLATE 1477—ONE-HALF SIZE

PLATE 1478—FULL SIZE

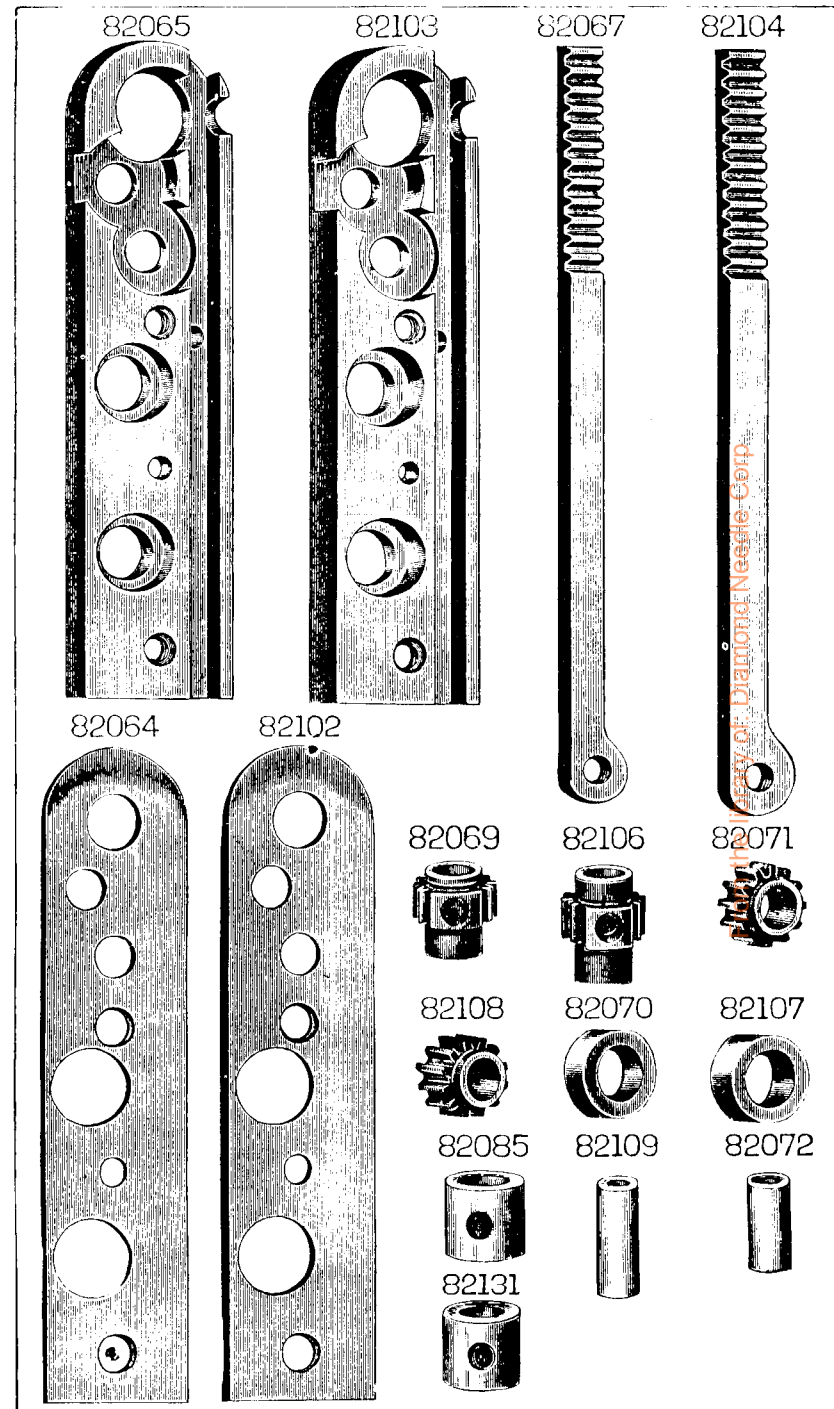
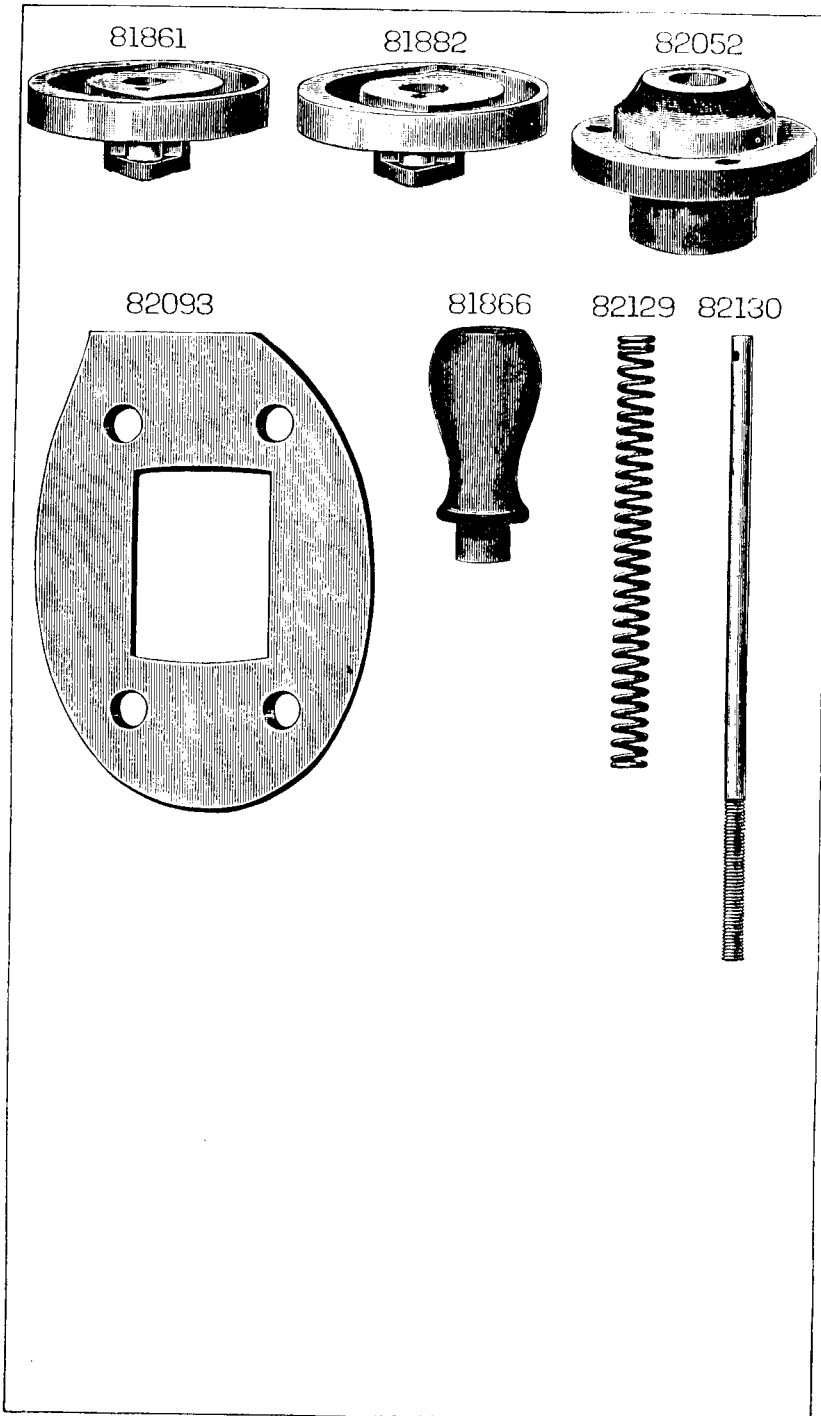



PLATE 1479—FULL SIZE

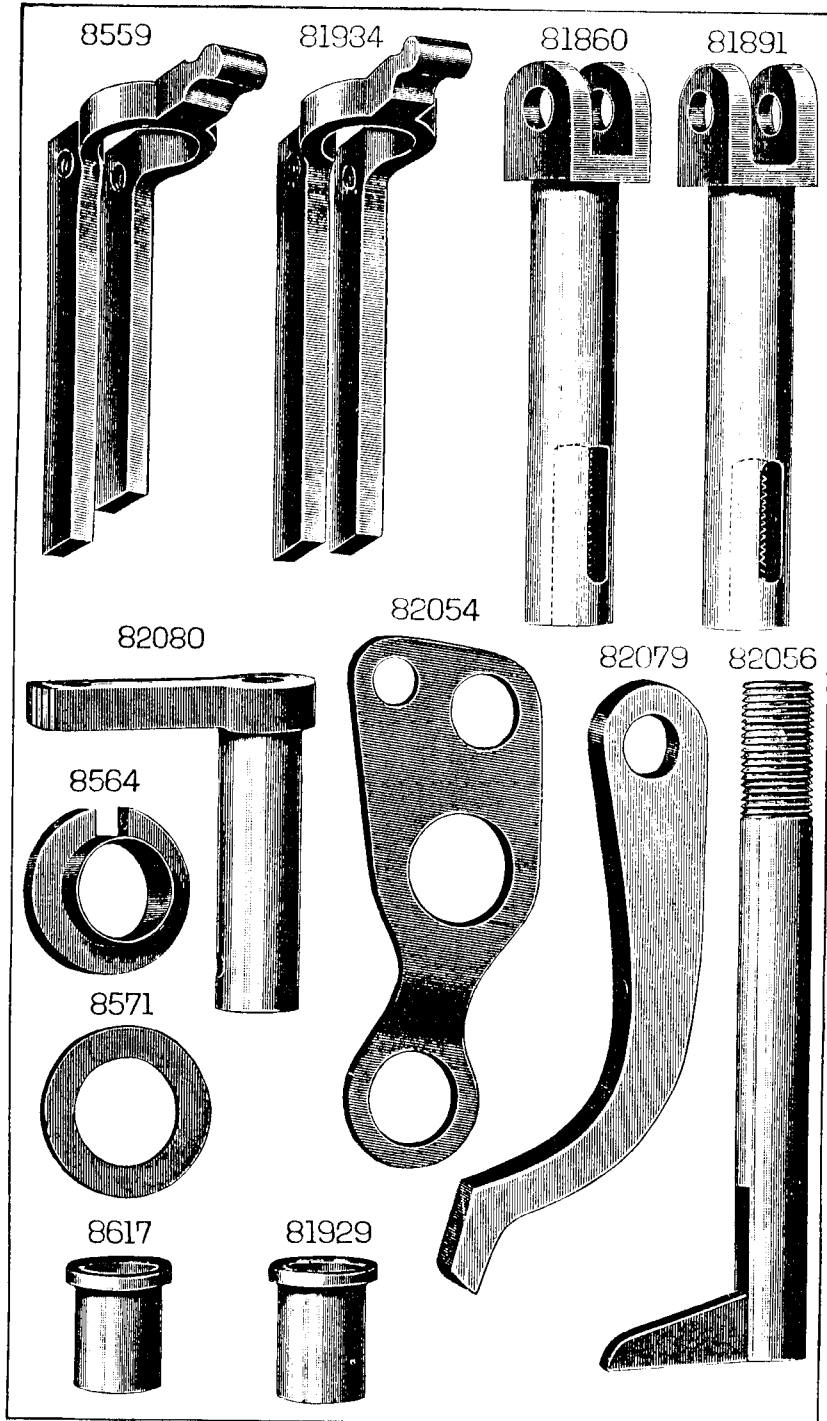

PLATE 1481—FULL SIZE

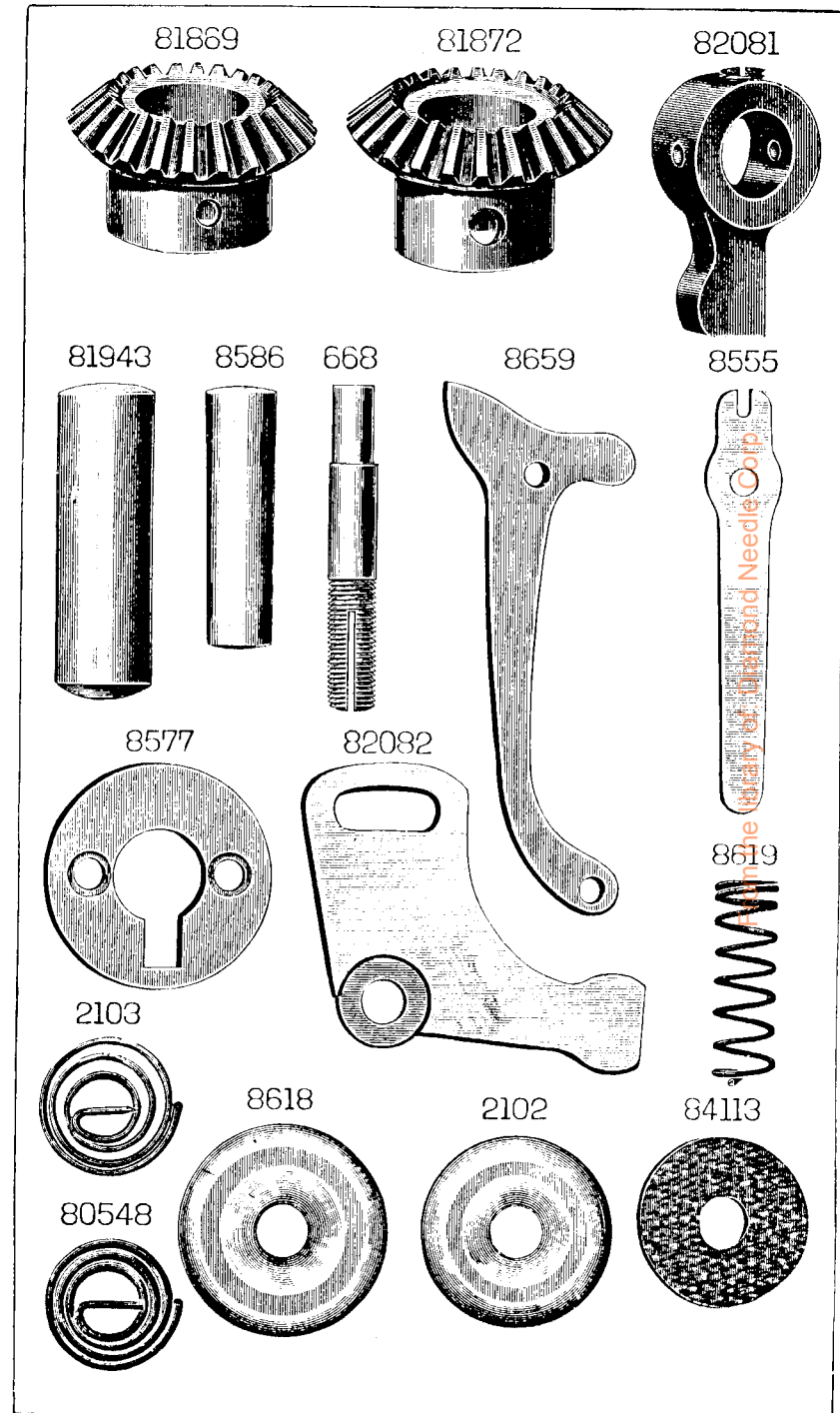

PLATE 1482—FULL SIZE

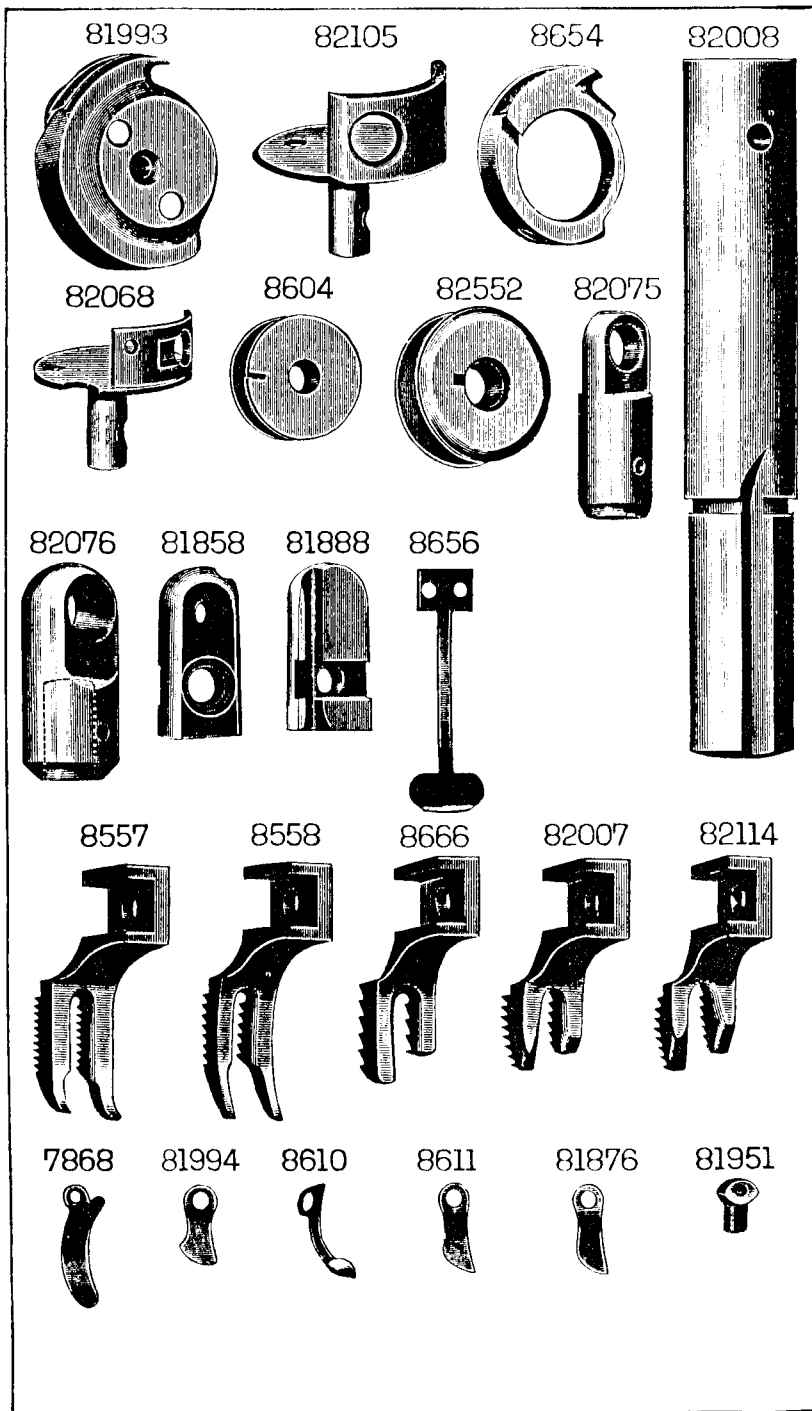

PLATE 1483—FULL SIZE

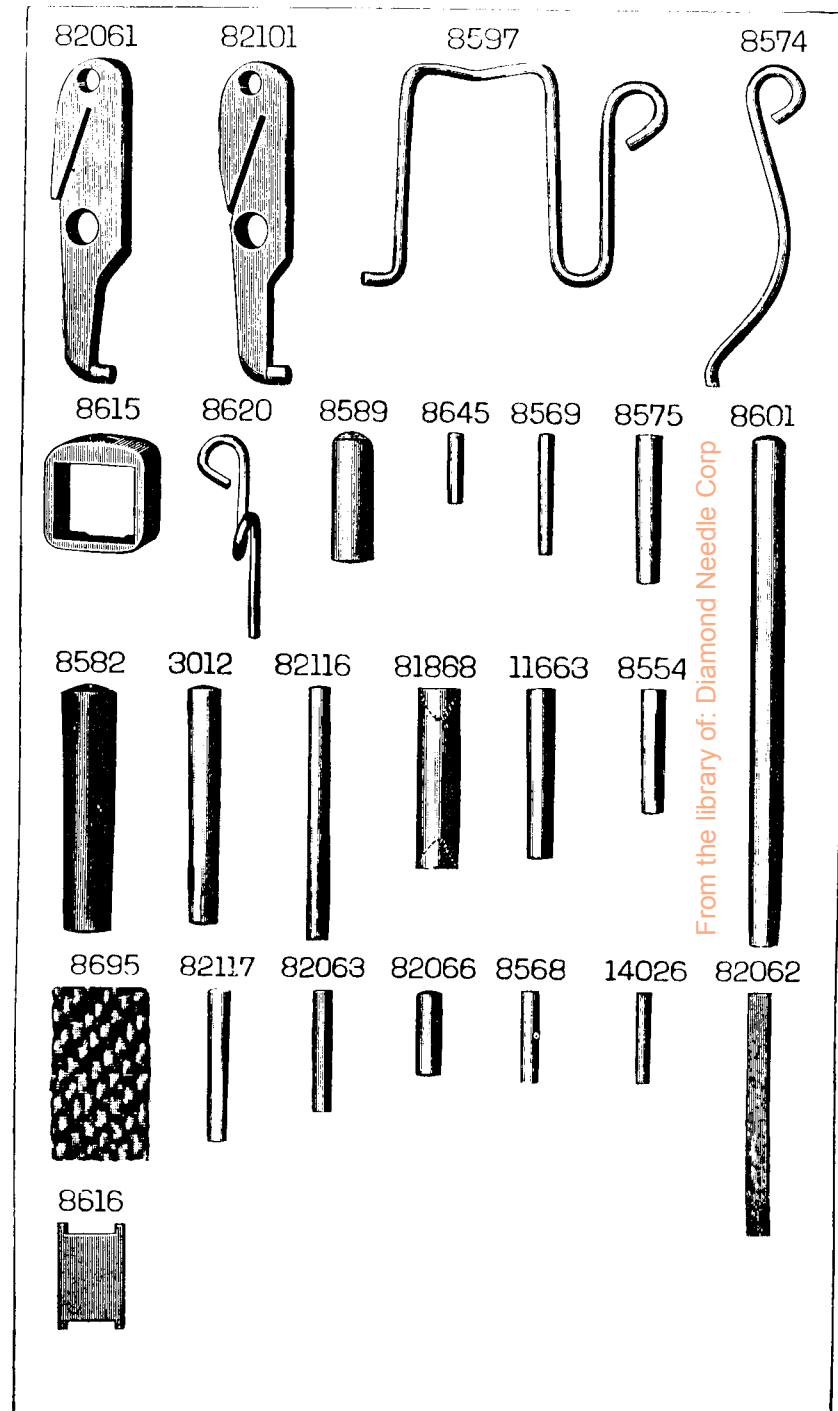

PLATE 1484—FULL SIZE

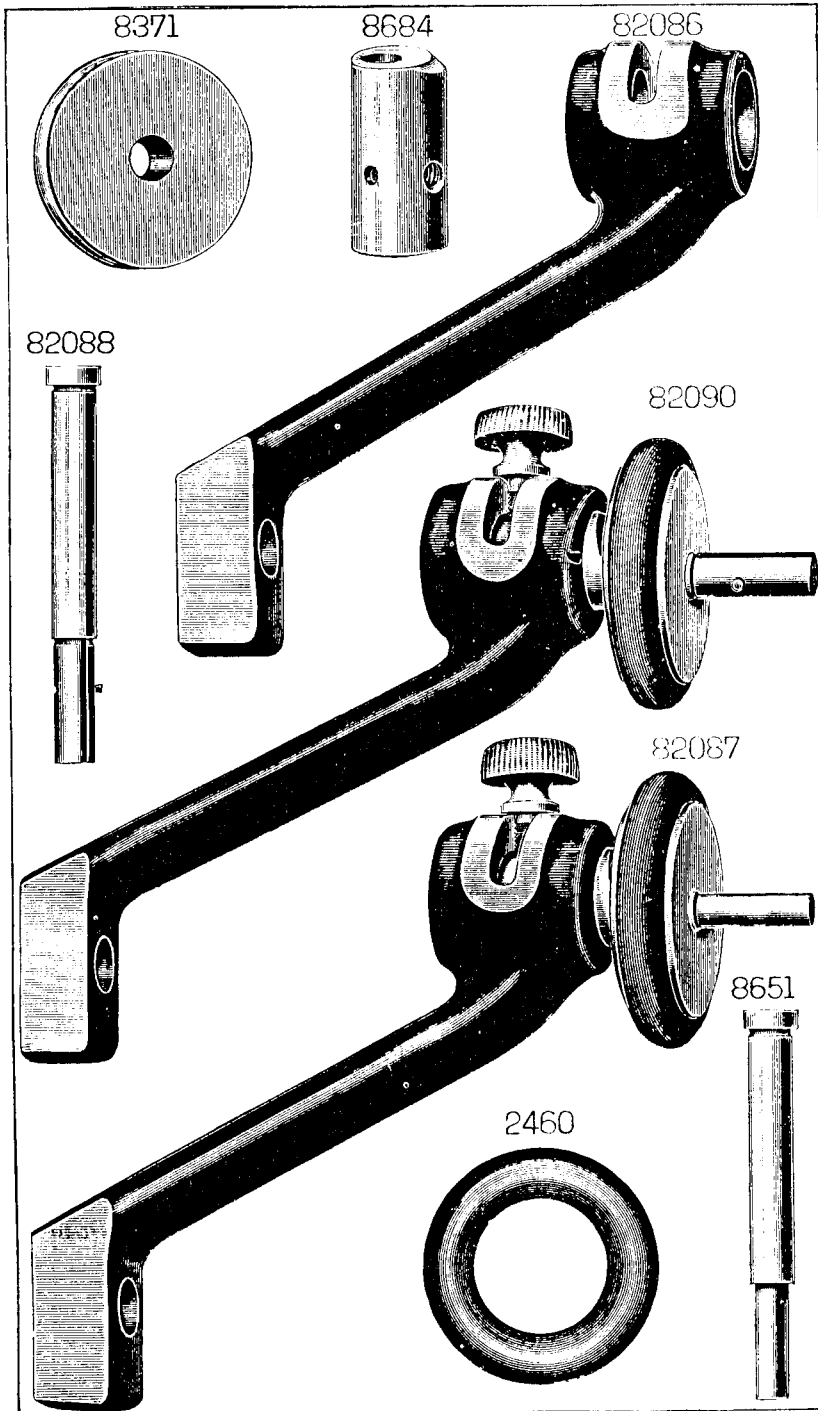

PLATE 1485—FULL SIZE

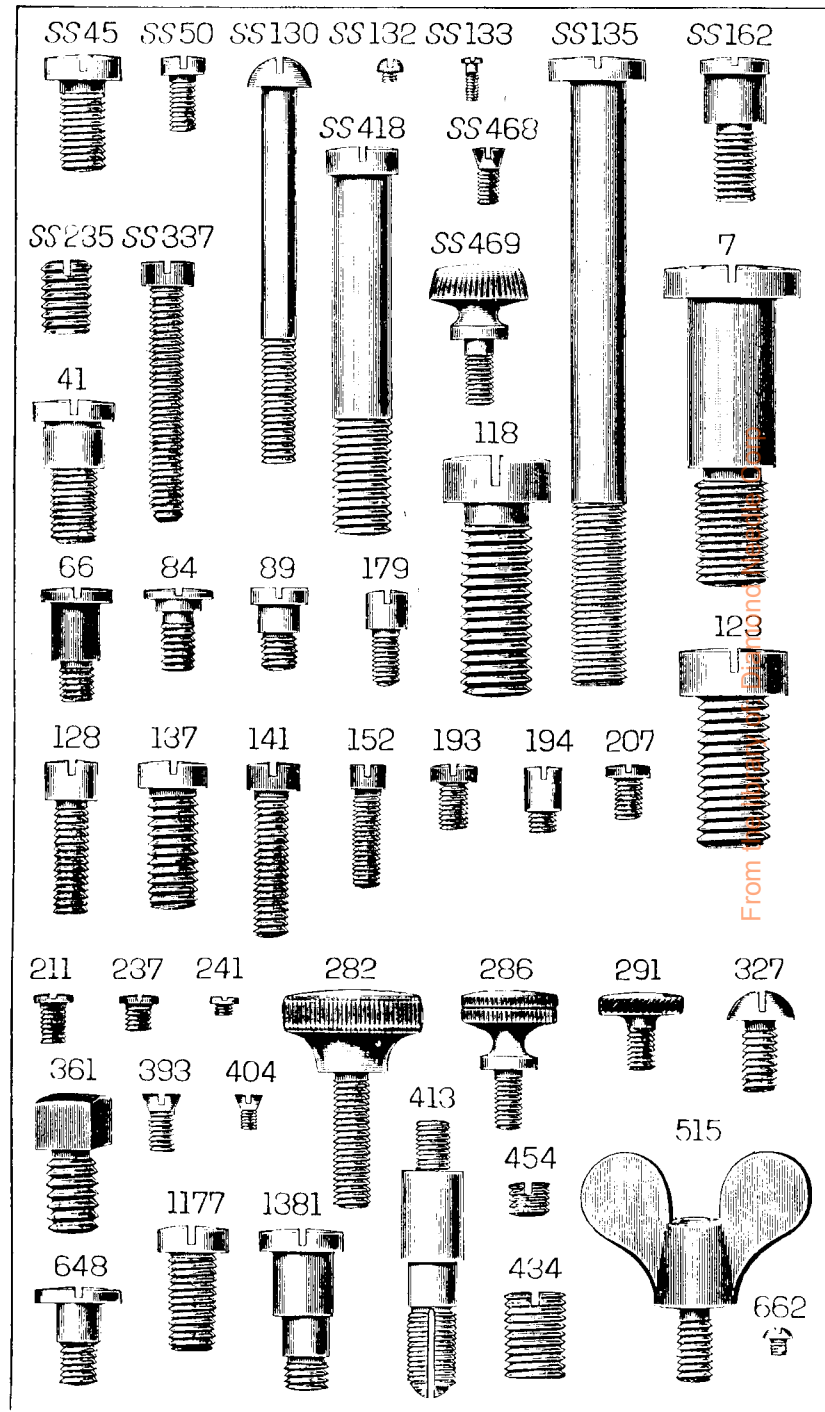
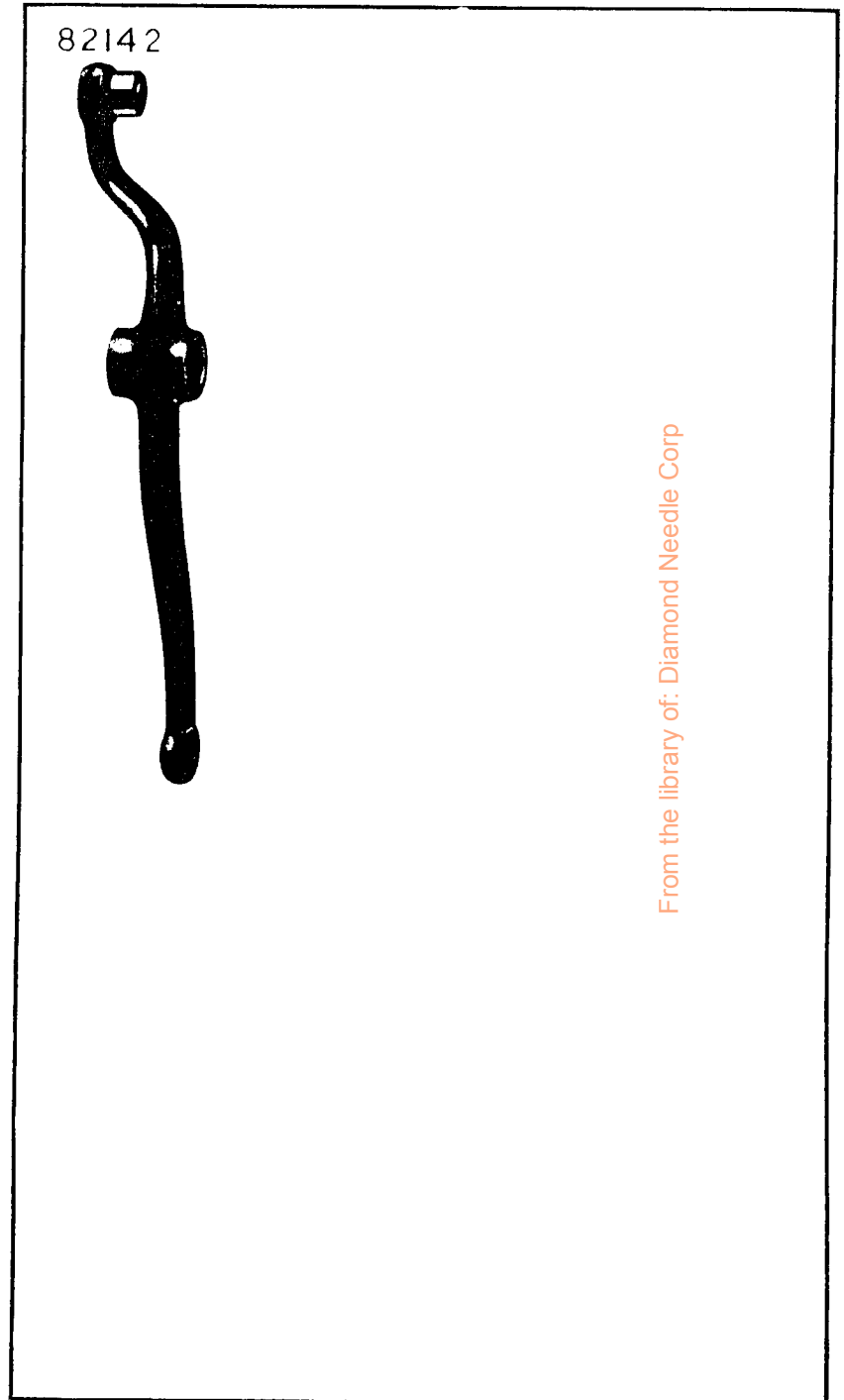
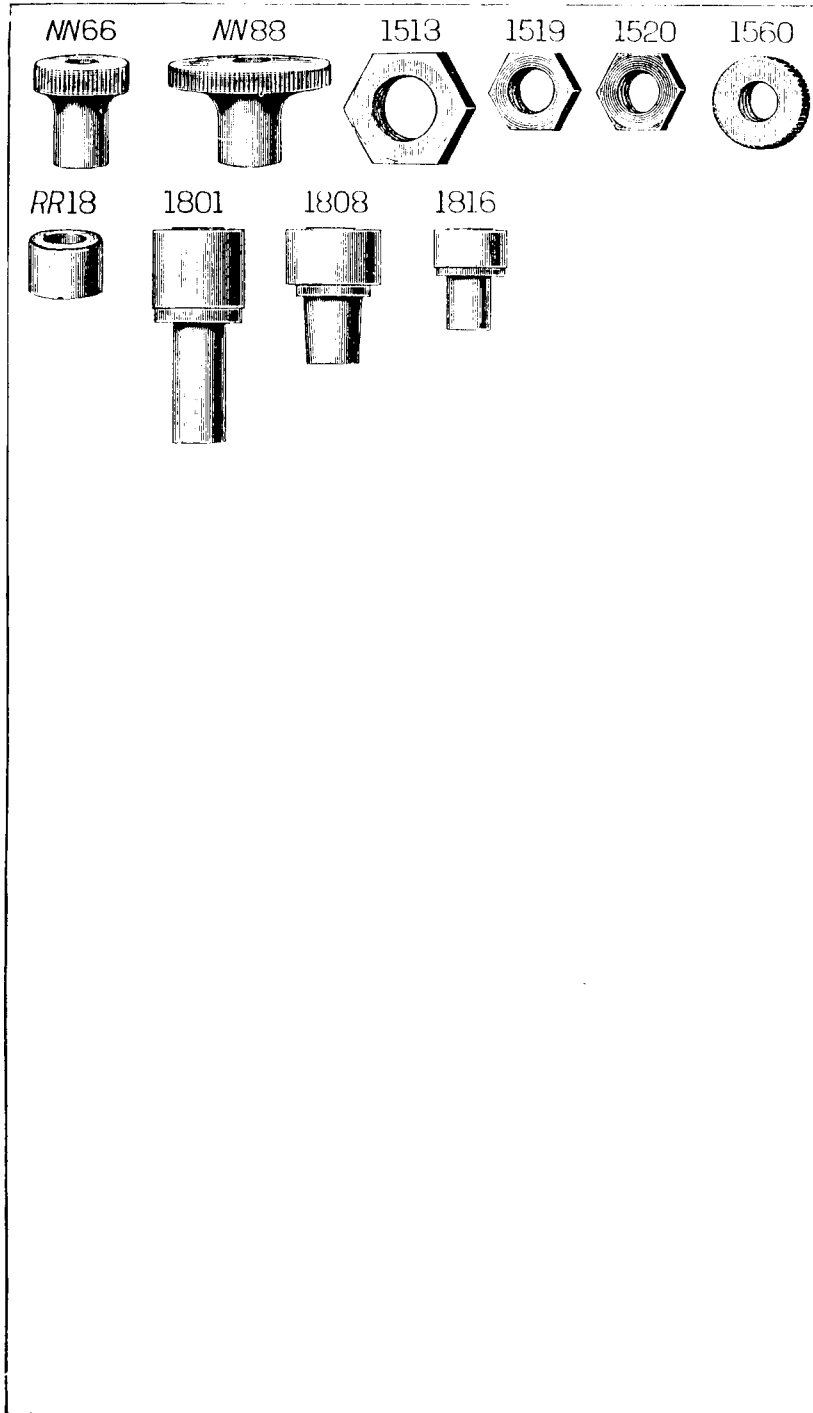

PLATE 1486—FULL SIZE

PLATE 1809—ONE-HALF SIZE



From the library of: Diamond Needle Corp

PLATE 1810—FULL SIZE

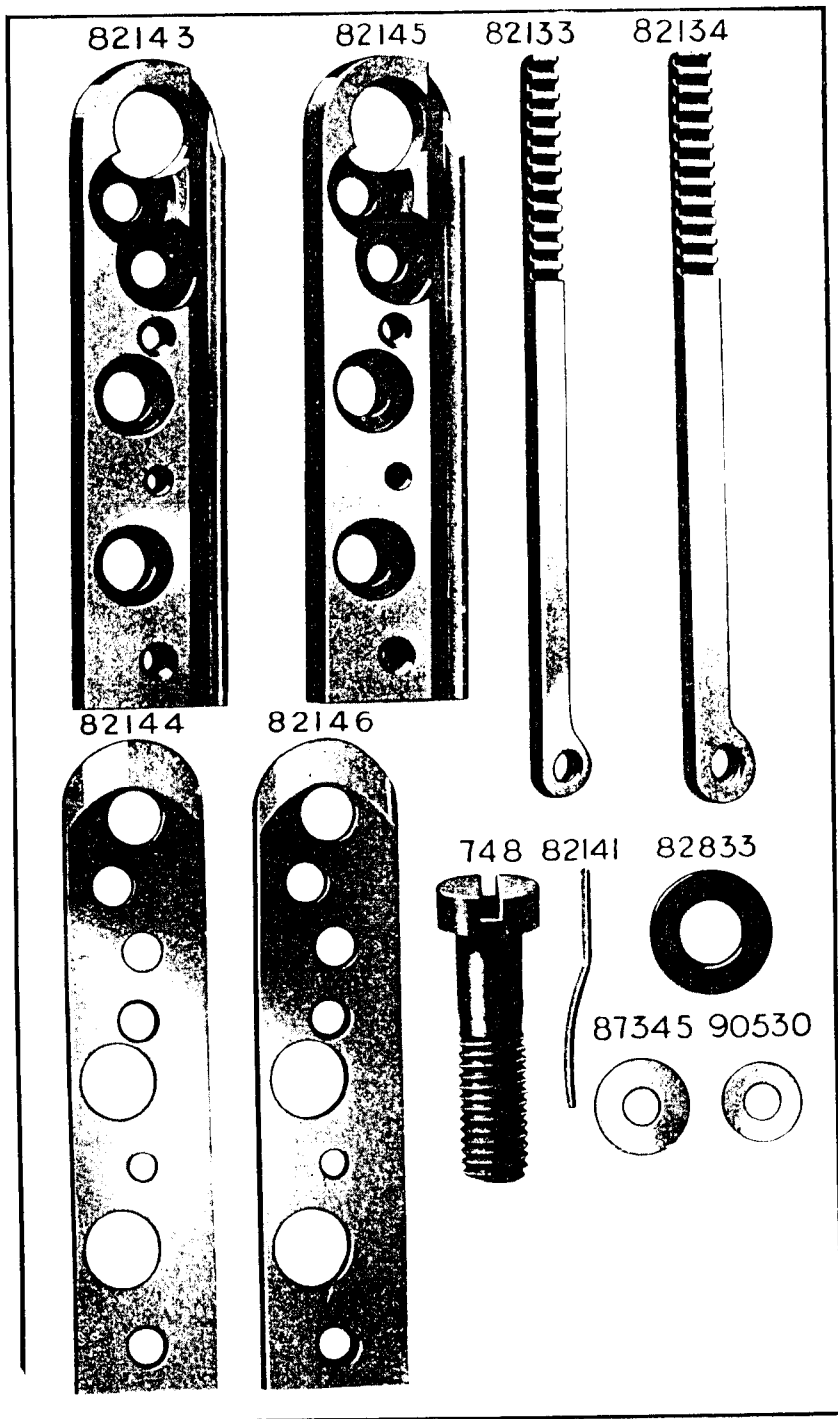

From the library of: Diamond Needle Corp